



YAMAHA CORPORATION
P.O.BOX1, Hamamatsu Japan



Printed in Japan
LPA669

P10028085

SPEAKERS for Commercial Installations

CATALOG 2017

*All specifications are subject to change without notice.
*All trademarks and registered trademarks are property of their respective owners.

 This document is printed with Vegetable Oil Ink.



Yamaha Commercial Installation Solutions





Inspired Sound

Yamaha knows sound. It is the driving force that inspires all of our creations, from concert grand pianos to professional mixing consoles. Our commercial installation speakers were designed by harnessing the wealth of experience we have acquired creating state-of-the-art pro audio equipment, as well as the unique musical sensibility that can only come from crafting world-class musical instruments— all the while maintaining the philosophy of sonic purity that has remained constant throughout our history. Yamaha has always striven to produce the most accurate and natural sound possible in order to give audio professionals and first-time users alike a pure sonic foundation to build on and create a signature sound. Drawing from this legacy of craftsmanship, innovation, and musicality, Yamaha speakers were designed to add new depth to an impressive range of commercial environments and ensure that all of your audio sounds inspired.

Inspired Sound

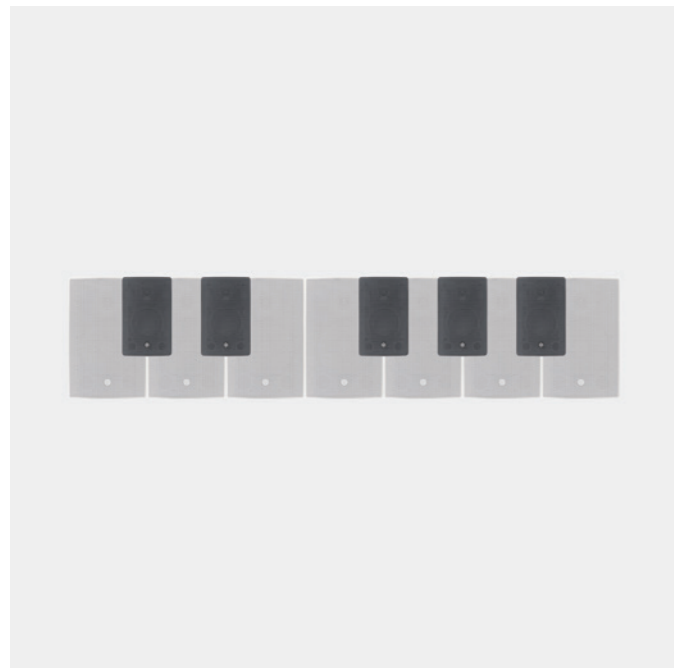

A fast, Easy Fit



Seamless In Any Space



Paintable for Perfect Visual Harmony



QUICK REFERENCE GUIDE



An ideal way to create appealing acoustic spaces

Basic models for a wide range of applications, easily handling music as well as announcements

SURFACE-MOUNT SPEAKER

VXS SERIES

P.11

IN-CEILING SPEAKER

VXC SERIES

P.17



VXS Series

VXC Series

For refined background music in elegant spaces

Premium sound tuning delivers superb sound quality at low volume

SURFACE-MOUNT SPEAKER Attractive, discreet design

VXS SERIES F

P.13

IN-CEILING SPEAKER Low-profile design

VXC SERIES F

P.19



VXS Series F

VXC Series F

Redefining the ultimate in compact design

Blurs the lines between audio and interior design

COMPACT SURFACE-MOUNT SPEAKER

VXS SERIES M **NEW**

P.9



For high-quality low-frequency enhancement

Subwoofers ideally matched to VXS Series and VXC Series speakers

SURFACE-MOUNT SUBWOOFER

VXS SERIES S **NEW**

P.15



For cost-sensitive installations

SURFACE-MOUNT SPEAKER

VS Series

P.21



For custom installations

SURFACE-MOUNT SPEAKER

NS-AW Series

P.23

IN-CEILING SPEAKER



















NS-IC Series

P.25



NS-AW Series

NS-IC Series

-  Full-range Speaker
-  IP Rating
-  2-way Speaker
-  Euroblock Type Terminal
-  Subwoofer
-  Barrier Strip Type Terminal
-  Horizontal Dispersion
-  Ceramic Type Terminal
-  Vertical Dispersion
-  Binding Post Type Terminal
-  Conical Dispersion
-  White & Black Model Available
-  Low & High Impedance Supported
-  White Model Only
-  Low Impedance Only
-  Paintable
-  High Impedance Only
-  EN54-24 Certified

All new series brings a fresh approach to compact design

VXS Series M **NEW**

Remarkably compact design



Premium sound with wide dispersion



VXS3S **NEW**

Compact enclosure delivers excellent low-frequency response



Lightweight design allows flexible installation





VXS Series M



- Redefining the ultimate in compact design
- Premium sound with wide dispersion ideal for background music
- Design combines beauty and function
- Optional hardware allows for extremely flexible installation



VXS1ML

- Type: Full-range, Acoustic Suspension
- Frequency Range (-10dB): 180Hz-20kHz
- Power Rating (PGM): 10W
- Sensitivity (1W, 1m): 79dB SPL
- Certificate: NFPA70, CE, RoHS

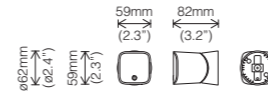

Net Weight: 0.17 kg (0.4 lbs)



CINECITTA, TILBURG (NETHERLANDS)

VXS Series



- An ideal way to create appealing acoustic spaces
 - All models easily handle music and announcements
 - Design that combines functional and visual beauty
 - Hardware supplied for safe, easy installation
 - EN54-24 certified models available (VA versions)*
- *Not available in some regions

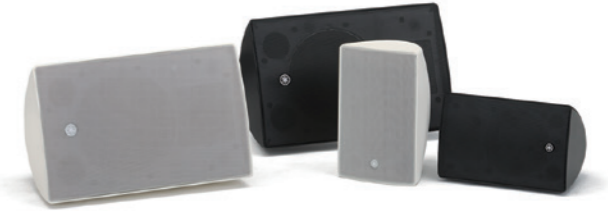

VXS5

- Type: 2-way, Bass-reflex
- Frequency Range (-10dB): 62Hz-20kHz
- Power Rating (PGM): 150W
- Sensitivity (1W, 1m): 89dB SPL
- Certificate: UL1480, NFPA70, CE, EAC, RoHS

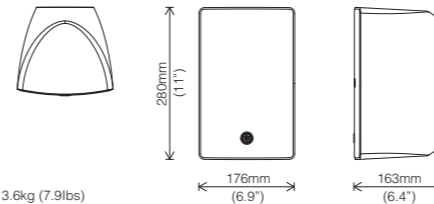
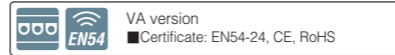
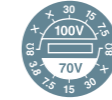

VXS8

- Type: 2-way, Bass-reflex
- Frequency Range (-10dB): 51Hz-20kHz
- Power Rating (PGM): 180W
- Sensitivity (1W, 1m): 91dB SPL
- Certificate: UL1480, NFPA70, CE, EAC, RoHS

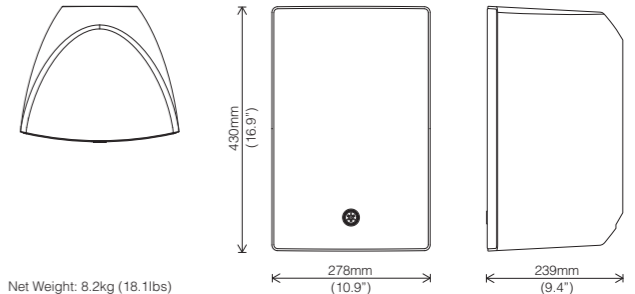
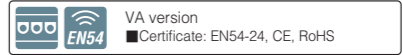
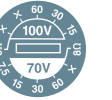



VXS Series F



- Premium sound tuning for refined background music
- Attractive, discreet design with slim installed profile for elegant spaces
- Designed optimized for low-impedance and high-impedance connections
- Hardware supplied for safe, easy installation



VXS3F

- Type: Full-range, Acoustic Suspension
- Frequency Range (-10dB): 130HZ-20kHz
- Power Rating (PGM): 40W
- Sensitivity (1W, 1m): 86dB SPL
- Certificate: UL1480, NFPA70, CE, RoHS

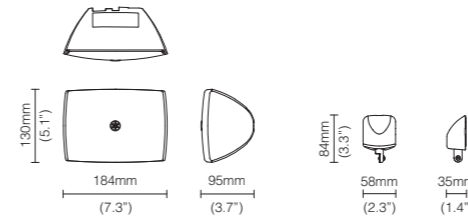

Net Weight (with Bracket): 1.1kg (2.4 lbs)

VXS3FT

- Full-range, Acoustic Suspension
- Frequency Range (-10dB): 130HZ-20kHz
- Power Rating (PGM): N/A
- Sensitivity (1W, 1m): 86dB SPL
- Certificate: UL1480, NFPA70, CE, EAC, RoHS

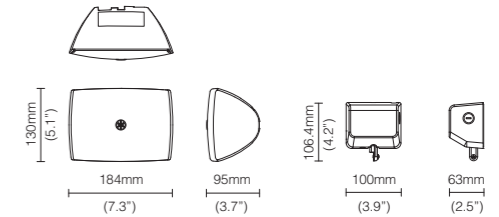
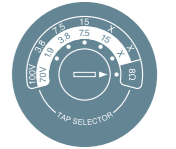

Net Weight (with Bracket): 1.7kg (3.7 lbs)



ITOYA, TOKYO (JAPAN)

VXS Series S

- Dedicated subwoofers for the VXS and VXC Series realizing high-quality low-frequency enhancement
- Ideal response can be achieved with a satellite connection*
- Designed optimized for low-impedance and high-impedance connections
- Choose according to your needs between the powerful VXS10S or compact VXS3S using Yamaha's original SR Bass™ technology



VXS10S/VXS10ST

- Type: Subwoofer, Bass-reflex
- Frequency Range (-10dB): 45Hz-250Hz
- Power Rating (PGM): 200W+200W (Dual Voice Coil)
- Sensitivity (1W, 1m): 96dB SPL
- Certificate: CE, RoHS, EAC (VXS10ST Only)

*Recommended for use with the VXS5/3F, VXC4/6/3F



*VXS10S



*VXS10ST

20V COM	1	C	4 COM 800V
200W	1	1	1 4 X
100W	2	2	2 4 200W
60W	3	3	3 4 100W
25W	4	4	4 4 50W

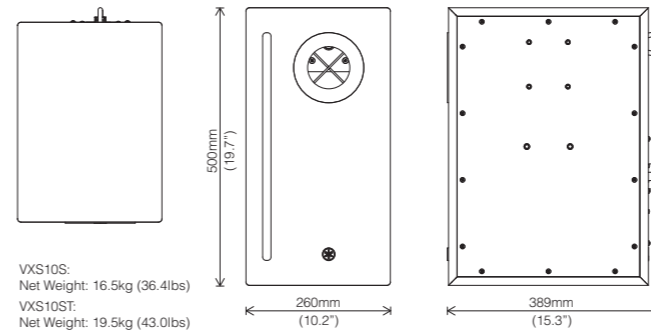

VXS10S:
Net Weight: 16.5kg (36.4lbs)
VXS10ST:
Net Weight: 19.5kg (43.0lbs)

VXS3S

- Type: Subwoofer, Dual SR-Bass™
- Frequency Range (-10dB): 65Hz-180Hz
- Power Rating (PGM): 40W
- Sensitivity (1W, 1m): 79dB SPL
- Certificate: NFPA70, CE, RoHS

*Recommended for use with VXS1M



Net Weight: 2.7kg (6.0lbs)

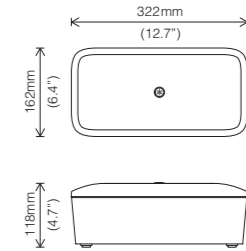



CAFE STYLO, TOKYO (JAPAN)

VXC Series

- An ideal way to create appealing acoustic spaces
- All models easily handle music and announcements
- Mechanical features for maximum installation speed and safety
- Simple design blends with just about any interior
- EN54-24 certified models available (VA versions)*

*Not available in some regions



VXC4

- Type: Full-range, Bass-reflex
- Frequency Range (-10dB): 80Hz-20kHz
- Power Rating (PGM): 60W
- Sensitivity (1W, 1m): 87dB SPL
- Certificate: UL1480, UL2043, NFPA70, CE, EAC, RoHS

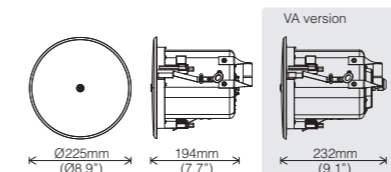
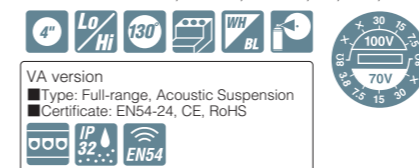

Net Weight: 2.6kg (5.7lbs)
Cutout Size: Ø186mm (7.3")

VXC6

- Type: 2-way (Coaxial), Acoustic Suspension
- Frequency Range (-10dB): 56Hz-20kHz
- Power Rating (PGM): 150W
- Sensitivity (1W, 1m): 86dB SPL
- Certificate: UL1480, UL2043, NFPA70, CE, EAC, RoHS

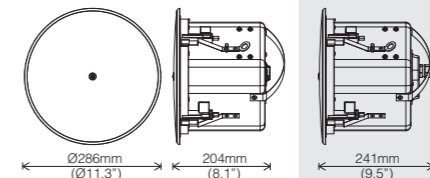
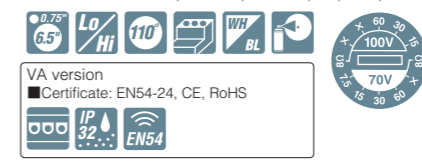

Net Weight: 4.4kg (9.7lbs)
Cutout Size: Ø247mm (9.8")

VXC8

- Type: 2-way (Coaxial), Acoustic Suspension
- Frequency Range (-10dB): 55Hz-20kHz
- Power Rating (PGM): 180W
- Sensitivity (1W, 1m): 90dB SPL
- Certificate: UL1480, UL2043, NFPA70, CE, EAC, RoHS

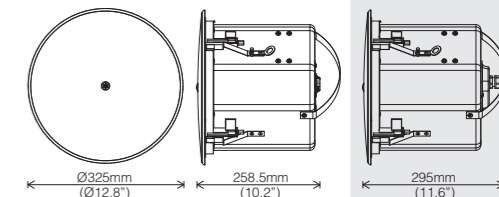
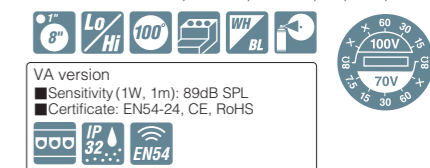

Net Weight: 6.6kg (14.6lbs)
Cutout Size: Ø285mm (11.3")



VXC Series F

- Premium sound tuning for refined background music
- Low-profile design for greater installation flexibility
- Mechanical features for maximum installation speed and safety
- EN54-24 certified models available (VA versions)*

*Not available in some regions

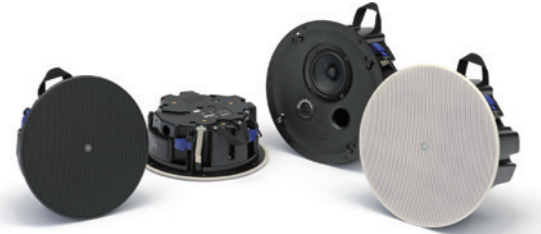

VXC3F

- Type: Full-range, Bass-reflex
- Frequency Range (-10dB): 71Hz-20kHz
- Power Rating (PGM): 40 W
- Sensitivity (1W, 1m): 87dB SPL
- Certificate: UL1480, NFPA70, CE, EAC, RoHS



VA version
 ■ Certificate: EN54-24, CE, RoHS

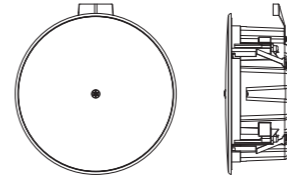
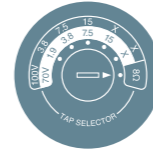

Net Weight: 2.5 kg (5.5 lbs)
 Cutout Size: Ø247mm (9.8")

Ø265mm
 (Ø11.3")

112mm
 (4.4")

VXC5F

- Type: Full-range, Bass-reflex
- Frequency Range (-10dB): 60Hz-20kHz
- Power Rating (PGM): 80 W
- Sensitivity (1W, 1m): 89 dB SPL
- Certificate: UL1480, NFPA70, CE, EAC, RoHS



VA version
 ■ Certificate: EN54-24, CE, RoHS

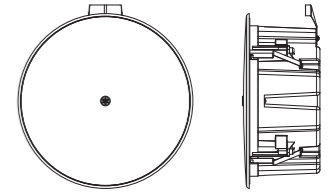
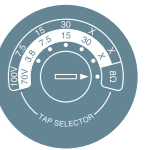

Weight: 3.1 kg (6.8 lbs)
 Cutout Size: Ø285mm (11.3")

Ø324mm
 (Ø12.8")

143mm
 (5.7")



VS Series

- Designed for cost-sensitive installations
- Lightweight speaker with built-in matching transformer
- Compact design suits indoor as well as outdoor installations
- Supplied hardware facilitates installation and angle adjustment



VS4

- Type: 2-way, Bass-reflex
- Frequency Range (-10dB): 100Hz-20kHz
- Power Rating (PGM): 30W
- Sensitivity (1W, 1m): 88dB SPL
- Certificate: UL1480, NFPA70, CE, EAC, RoHS

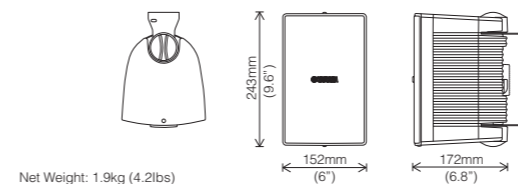
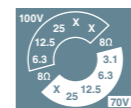

VS6

- Type: 2-way, Bass-reflex
- Frequency Range (-10dB): 80Hz-20kHz
- Power Rating (PGM): 50W
- Sensitivity (1W, 1m): 90dB SPL
- Certificate: UL1480, NFPA70, CE, EAC, RoHS

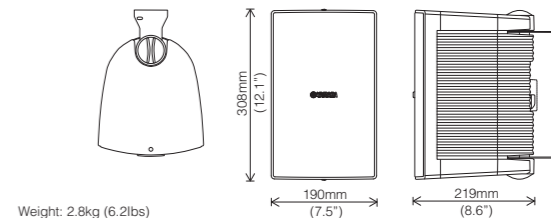
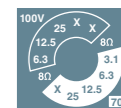



NS-AW Series

*Not available in some regions

- Designed for custom installations
- Angled cabinet design blends beautifully with most interiors
- All-weather design provides durability for outdoor applications
- Supplied hardware facilitates installation and angle adjustment



NS-AW392

- Type: 2-way, Acoustic Suspension
- Frequency Range (-10dB): 60Hz-25kHz
- Power Rating (PGM): 40W
- Sensitivity (1W, 1m): 86dB SPL
- Certificate: CE, RoHS

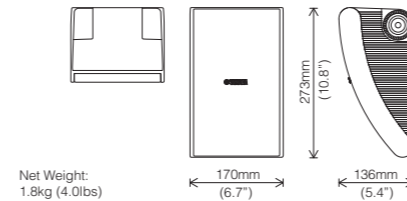

NS-AW592

- Type: 2-way, Acoustic Suspension
- Frequency Range (-10dB): 55Hz-20kHz
- Power Rating (PGM): 50W
- Sensitivity (1W, 1m): 88dB SPL
- Certificate: CE, RoHS

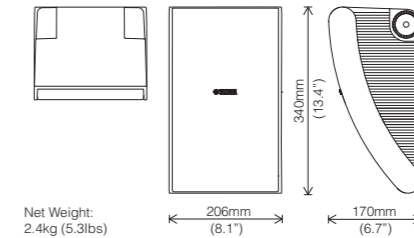

NS-AW992

- Type: 2-way, Acoustic Suspension
- Frequency Range (-10dB): 50Hz-20kHz
- Power Rating (PGM): 60W
- Sensitivity (1W, 1m): 90dB SPL
- Certificate: CE, RoHS

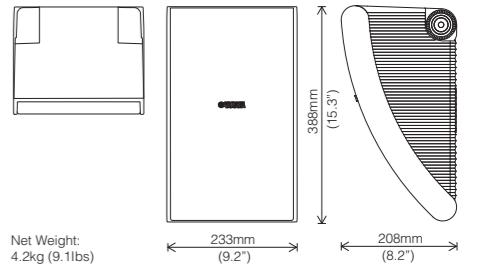



NS-IC Series

*Not available in some regions

- Designed for custom installations
- Slim ceiling mount design allows installation in tight spaces
- Magnet-latch grille contributes to fast setup
- Simple design blends with just about any interior



NS-IC400

- Type: Full-range, Open back
- Frequency Range (-10dB): 95Hz-40kHz
- Power Rating (PGM): 30W
- Sensitivity (1W, 1m): 85dB SPL
- Certificate: CE, RoHS

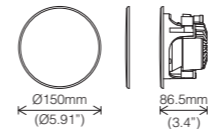

Net Weight: 0.8kg (1.8lbs)
Cutout Size: Ø122mm (4.8 inch)

NS-IC600

- Type: 2-way (Coaxial), Open back
- Frequency Range (-10dB): 65Hz-28kHz
- Power Rating (PGM): 40W
- Sensitivity (1W, 1m): 90dB SPL
- Certificate: CE, RoHS

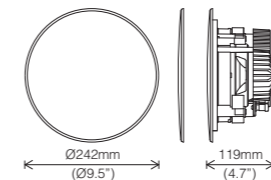

Net Weight: 1.5kg (3.3lbs)
Cutout Size: Ø204mm (8.0 inch)

NS-IC800

- Type: 2-way (Coaxial), Open back
- Frequency Range (-10dB): 50Hz-28kHz
- Power Rating (PGM): 50W
- Sensitivity (1W, 1m): 90dB SPL
- Certificate: CE, RoHS

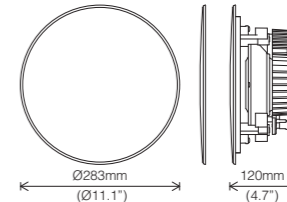

Net Weight: 1.9kg (4.2lbs)
Cutout Size: Ø245mm (9.6 inch)

NS-ICS600

- Type: 2-way (Coaxial), Open back
- Frequency Range (-10dB): 65Hz-28kHz
- Power Rating (PGM): 20W + 20W (Dual Voice Coil)
- Sensitivity (1W, 1m): 89dB SPL
- Certificate: CE, RoHS

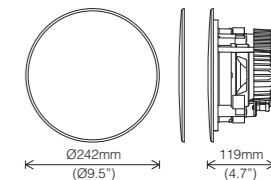

Net Weight: 1.8kg (4.0lbs)
Cutout Size: Ø204mm (8.0 inch)